

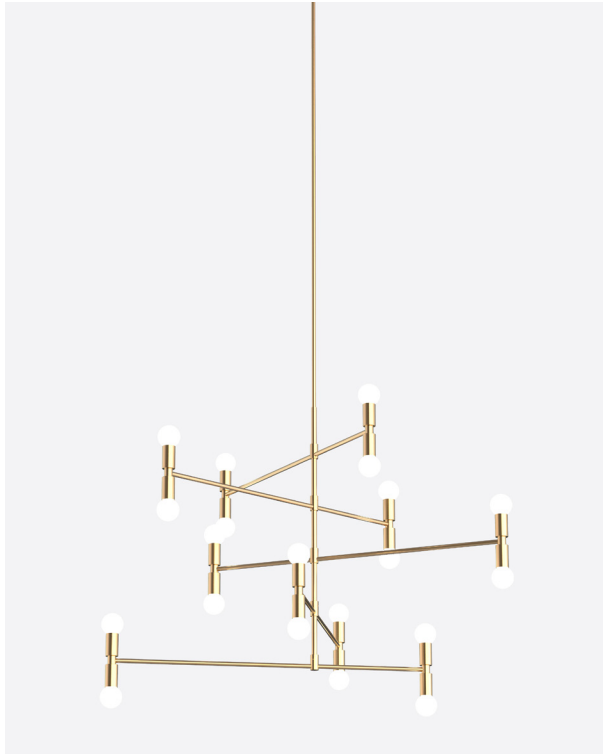



## DOT 14



A



B

<b>Type</b>	Suspension	
<b>Materials</b>	Body:	brass
	Sphere:	milk glass (G50)
	Hardware:	brass
<b>Total Height</b>	Height to be specified upon order	
<b>Weight (min.)</b>	A	min. 6 lb / 2.7 kg
	B	min. 6 lb / 2.7 kg
	C	min. 7 lb / 3.2 kg
<b>Light Bulb</b>	A	LED (included), 20x 3.5W
	B	LED (included), 12x 3.5W
	C	LED (included), 20x 3.5W
<b>Sockets</b>	G9	
<b>Voltage</b>	120V / 240V	
<b>Dimmer</b>	Refer to our recommended list of dimmer models	
<b>Certifications</b>	  	
<b>Notes</b>	<ul style="list-style-type: none"> <li>• Must be installed by an electrician</li> <li>• Additional charges for modifications</li> <li>• Lead time between 7-9 weeks</li> <li>• Dimensions are approximate and may vary slightly</li> </ul>	

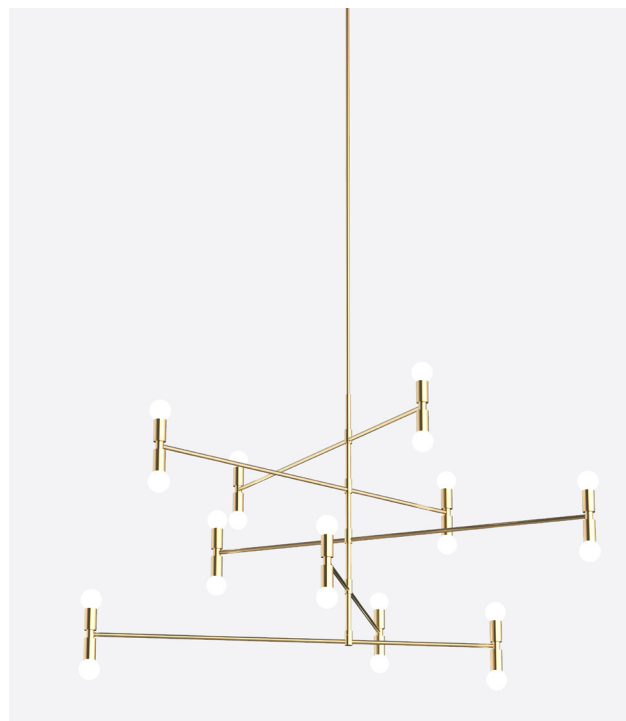

C

A

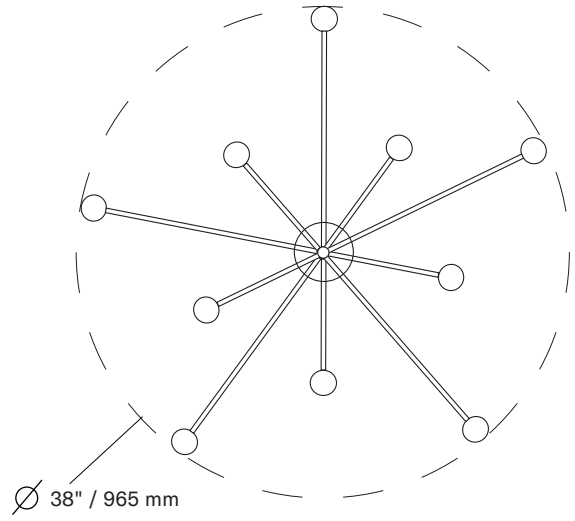
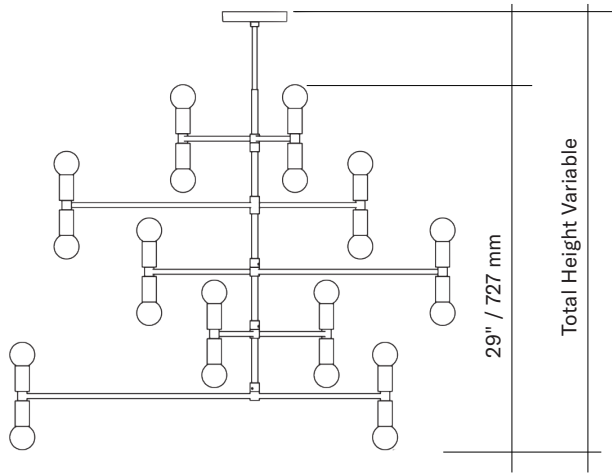

B

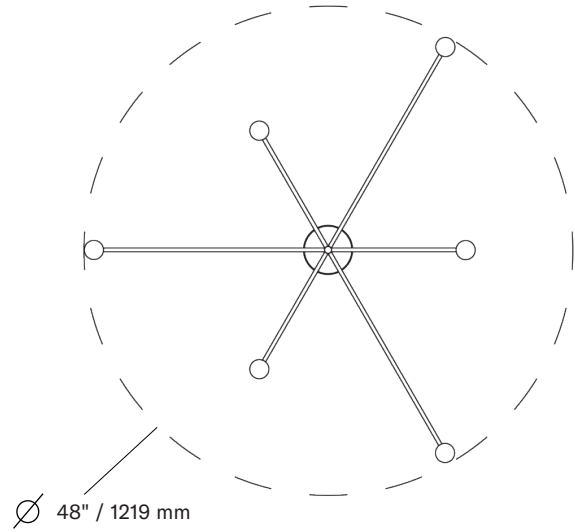
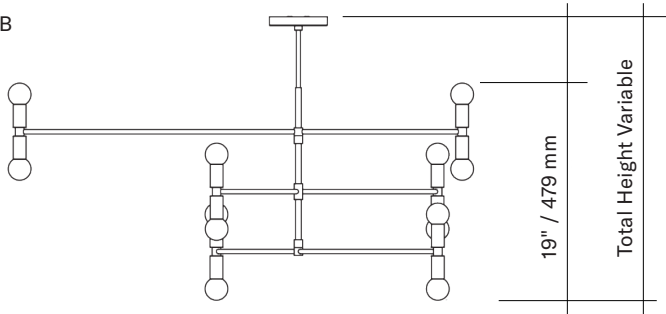

C

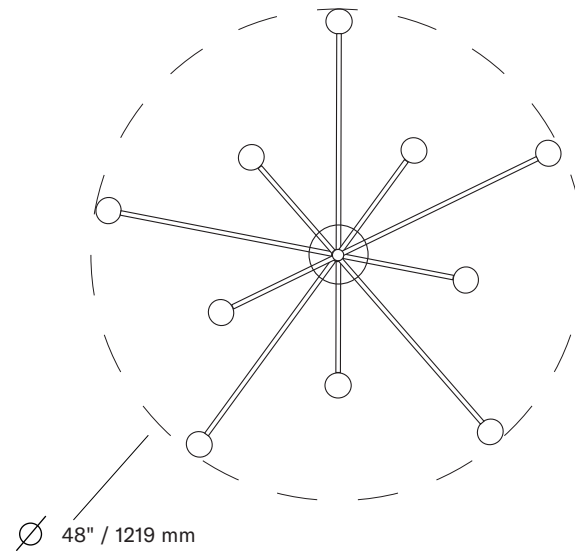
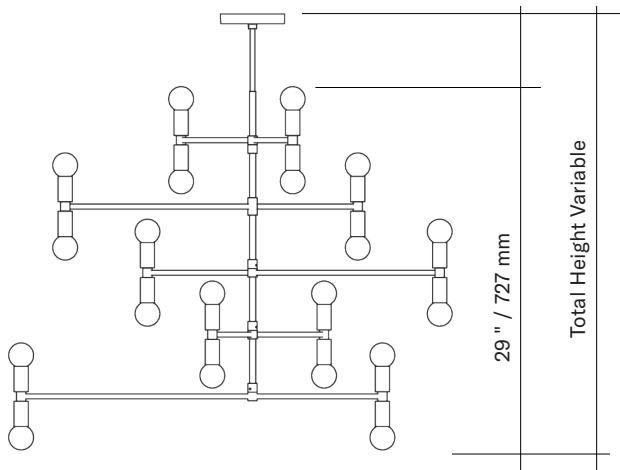

## Order Guide: SKU

Collection		Model	Finish	Size
DOT	Dot	14	BR Brass	A $\varnothing$ 38" / 965mm 5 Level
			GR Graphite	B $\varnothing$ 48" / 1219mm 3 Level
				C $\varnothing$ 48" / 1219mm 5 Level
DOT		14	BR	A = DOT14BRA
				<b>example</b>

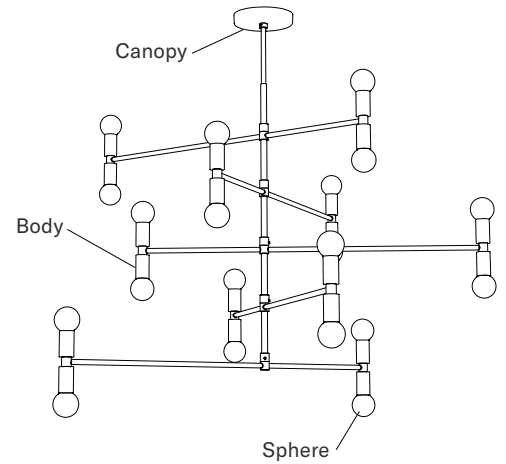

### Finish

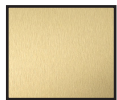

Brass



Graphite

### Canopy

Swivel option for slanted ceiling

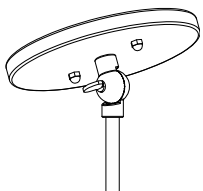

## Light Bulb & Dimmer Specifications

### G9 Sockets

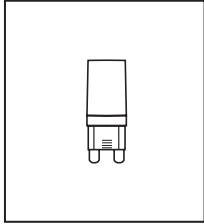

Frosted  
3.5W  
100V-120V / 240V  
350 Lumens  
2,700K  
25,000H  
CRI ≥ 80  
2 years warranty

### Spheres



G50  $\varnothing$  ± 2" / 50 mm



### DIMMER LIST COMPATIBILITY FOR G9 LED BULBS – 120V

The dimming technology offering the best results is ELV (electronic low voltage) dimmers with reverse phase or trailing edge control.

<u>DIMMER BRAND</u>	<u>MODEL NUMBER</u>	<u>MAX LEVEL</u>	<u>MIN LEVEL</u>	<u>FLICKERING</u>	<u>OVERALL QUOTE</u>
LUTRON - MAESTRO	MAELV-600	100%	0%	0%-10%	good
LUTRON - SKYLARK	SELV-300P	100%	0%	no	very good
LUTRON - SKYLARK	SELV-303P	100%	0%	no	very good
LUTRON - SKYLARK	CTELV-303P	100%	0%	no	very good
LUTRON - DIVA	DVELV-300P	100%	0%	no	very good
LEGRAND - ADORNE	TRUE UNIVERSAL	100%	30%	no	good

### DIMMER LIST COMPATIBILITY FOR G9 LED BULBS – 230V

<u>DIMMER BRAND</u>	<u>MODEL NUMBER</u>	<u>MAX LEVEL</u>	<u>MIN LEVEL</u>	<u>FLICKERING</u>	<u>OVERALL QUOTE</u>
VARILIGHT	V-PRO	100%	2%	no	very good
LEGRAND - NILOÉ	3 996 35	87%	15%	no	good
NIKO	310-0280X	94%	5%	no	very good
NIKO	310-0190X	100%	1%	no	very good

\*Other dimmers can yield good results and we recommend conducting your own test before final installation.